

Vortex Phase Plate

VPP-1a

Properties	
Master	u6243E
Pattern dimension	~50 x 50
Vortex aperture	10 x 10mm
Charge	1
Material	Polymer replicated on glass substrate
Index of refraction	1.56
Transmission spectrum	350-2000nm
Temperature range	-150°C to 120°C

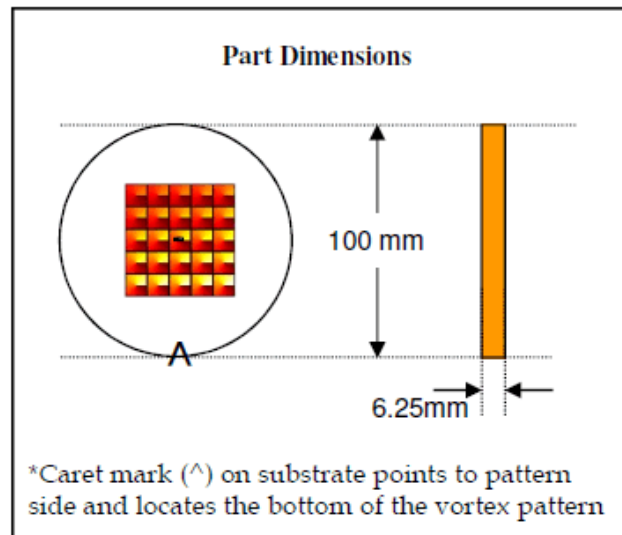

Wavelength Map for 2π Phase Depth

527.0	512.5	487.3	466.2	443.9
629.2	620.4	596.5	576.7	560.8
735.8	727.7		688.9	678.8
849.9	844.2	826.6	807.3	796.3
990.8	999.7	983.6	959.8	939.4

^

*Pattern side up

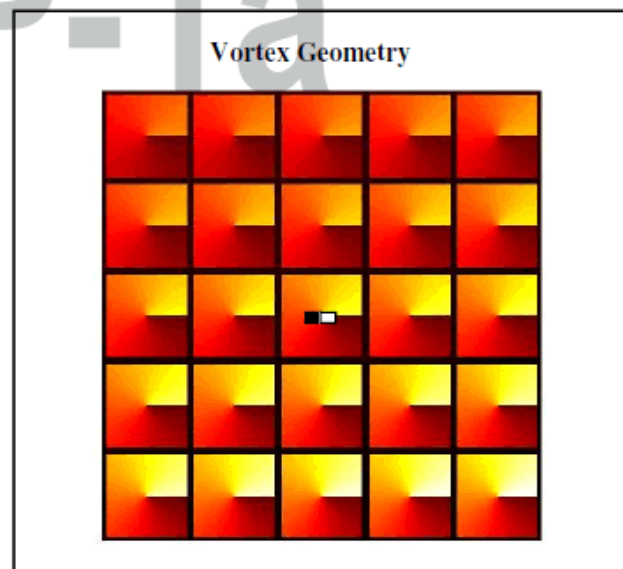

Vortex Phase Plate

VPP-1b

Properties	
Master	u9182E
Pattern dimension	~50 x 50
Vortex aperture	10 x 10mm
Charge	1
Material	Polymer replicated on glass substrate
Transmission spectrum	350-2000nm
Temperature range	-150°C to 120°C
Defects	None

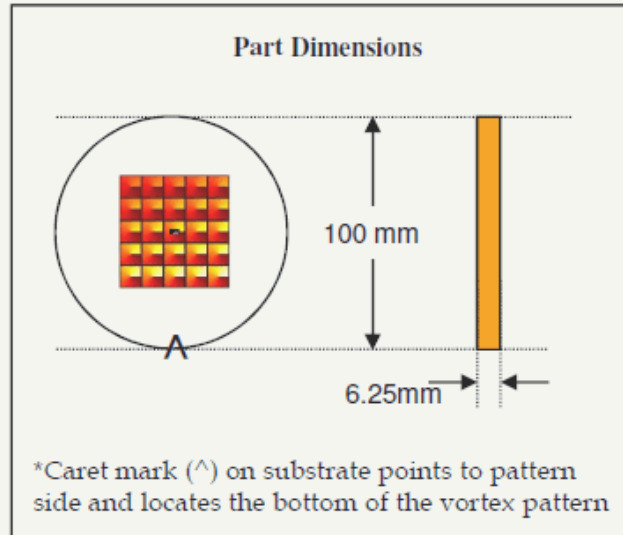

Wavelength Map for 2π Phase Depth

339	365	372	375	398
407	418	432	463	542
548	539		552	582
683	671	708	735	794
858	953	969	1193	1450



*Pattern side up

Vortex Geometry

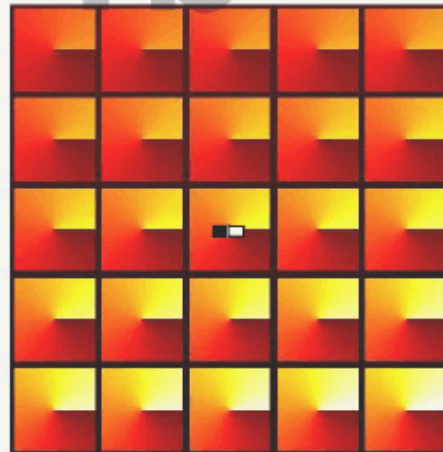

Vortex Phase Plate

VPP-1c

Properties	
Master	u9271E
Pattern dimension	~50 x 50
Vortex aperture	10 x 10mm
Charge	1
Material	Polymer replicated on glass substrate
Transmission spectrum	350-2000nm
Temperature range	-150°C to 120°C
Defects	None

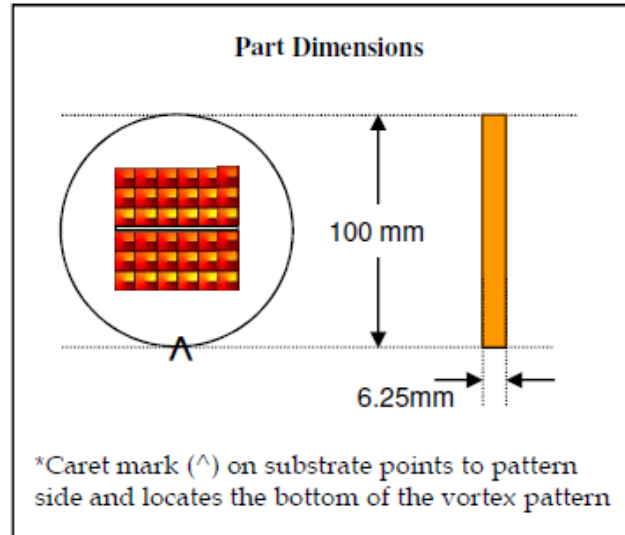

Wavelength Map for 2π Phase Depth

1515	1471	1504	1515	1471	1455
1531	980	854	606	1520	1466
1563	490	395	388	474	1542
1542	534	455	411	607	1536
1520	1081	779	721	885	1515
1509	1477	1498	1515	1520	1525

^

*Pattern side up
 Blue boundary indicates clear aperture

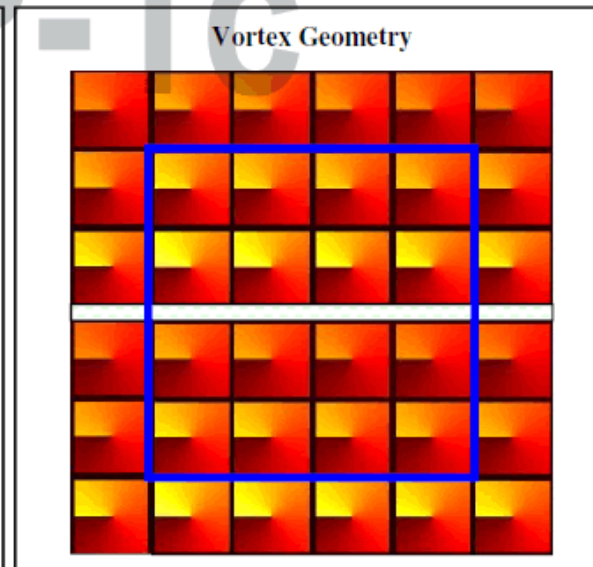

Vortex Phase Plate

VPP-2

Properties	
Master	u7155E
Pattern dimension	~50 x 50
Vortex aperture	10 x 10mm
Charge	2
Material	Polymer replicated on glass substrate
Index of refraction	1.56
Transmission spectrum	350-2000nm
Temperature range	-150°C to 120°C
Defects	None

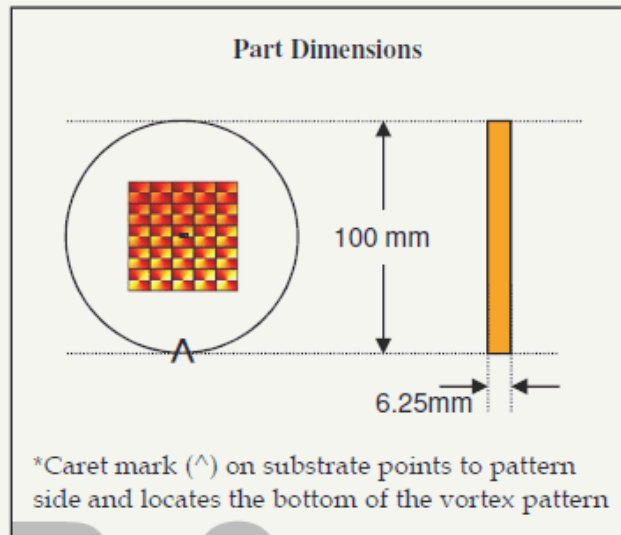

Design wavelength, nm (master u7155E)

465.2	436.1	419.1	394.0	370.1
598.0	567.8	544.4	521.0	493.6
748.5	708.9		661.2	638.2
897.0	851.9	828.8	806.7	779.8
1026.8	1004.1	978.1	954.3	925.7

^

*Pattern side up

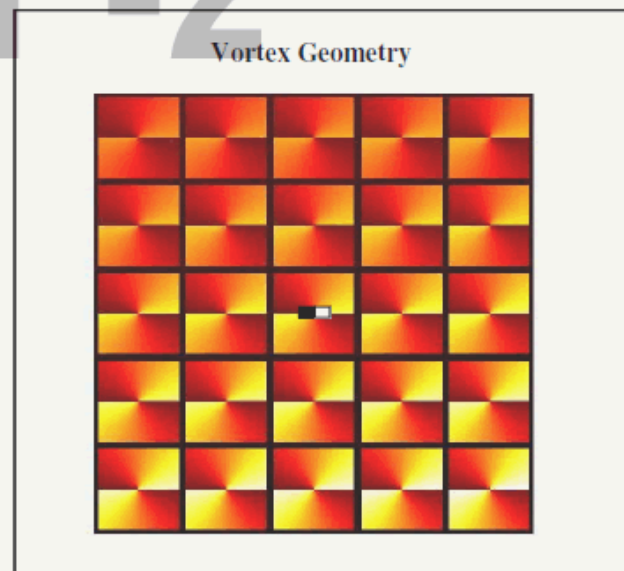

Vortex Phase Plate

VPP-m589

Properties	
Master	U13092E
Pattern dimension	~50 x 50
Vortex aperture	10 x 10mm
Charge	Various
Wavelength	589nm
Material	Polymer replicated on glass substrate
Transmission spectrum	350-2000nm
Temperature range	-150°C to 120°C
Defects	None

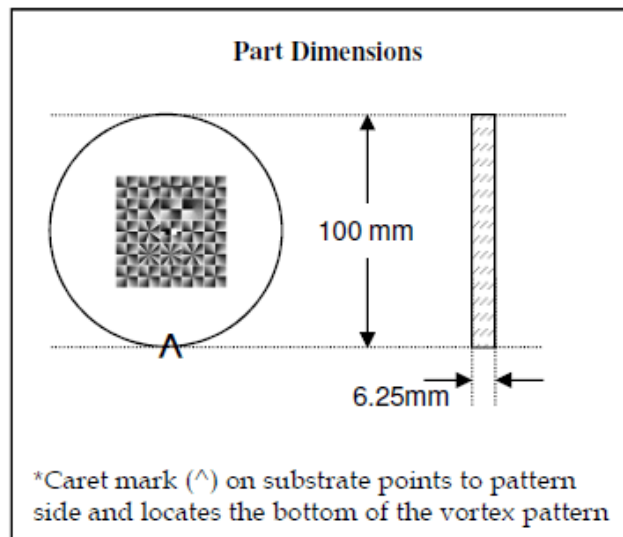

Charge Map

4	4	4	4	4
4	3	2	1	4
4	5		4	4
4	8	7	6	4
4	4	4	4	4

^

*Pattern side up
Blue boundary indicates clear aperture

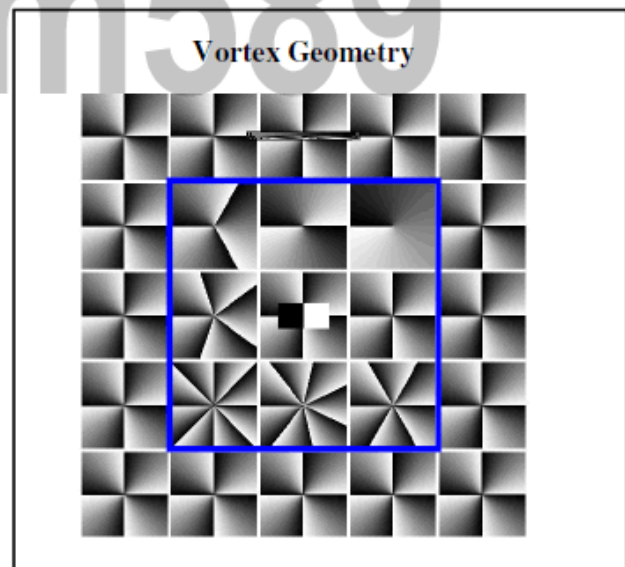

Vortex Phase Plate

VPP-m633

Properties	
Master	u9317E
Pattern dimension	~50 x 50
Vortex aperture	10 x 10mm
Charge	Various
Wavelength	633 nm
Material	Polymer replicated on glass substrate
Transmission spectrum	350-2000nm
Temperature range	-150°C to 120°C
Defects	None

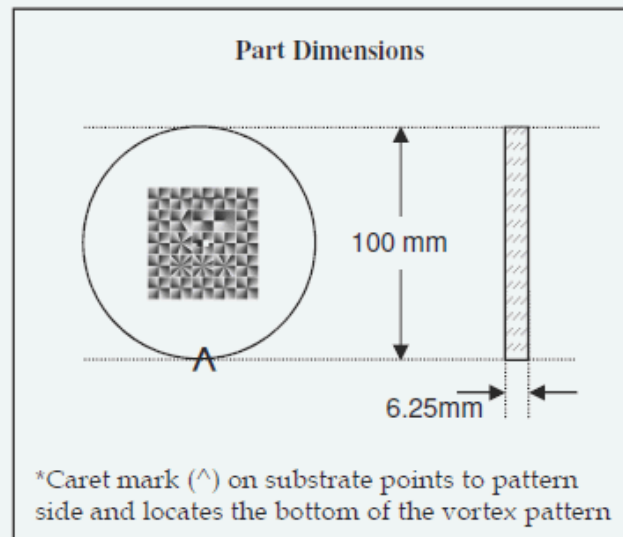

Charge Map

4	4	4	4	4
4	3	2	1	4
4	5		4	4
4	8	7	6	4
4	4	4	4	4



*Pattern side up
 Blue boundary indicates clear aperture

Vortex Geometry

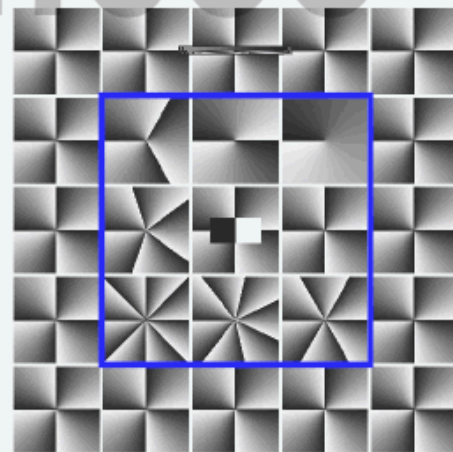

Vortex Phase Plate

VPP-m780

Properties	
Master	u14387E
Pattern dimension	~50 x 50
Vortex aperture	10 x 10mm
Phase depth tolerance	±3% (typ.)
Charge	Various
Wavelength	780 nm
Material	Polymer replicated on glass substrate
Transmission spectrum	350-2000nm

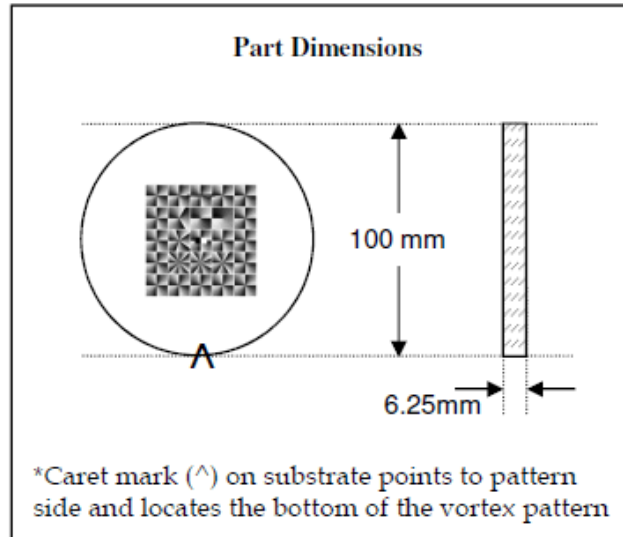

Charge Map

4	4	4	4	4
4	3	2	1	4
4	5		4	4
4	8	7	6	4
4	4	4	4	4

^

*Pattern side up
Blue boundary indicates clear aperture

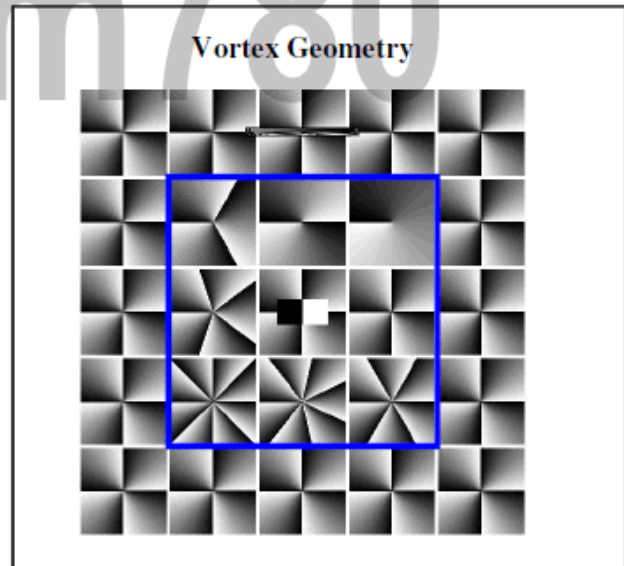

Vortex Phase Plate

VPP-m1064

Properties	
Master	u9311E
Pattern dimension	~50 x 50
Vortex aperture	10 x 10mm
Charge	Various
Wavelength	1064 nm
Material	Polymer replicated on glass substrate
Transmission spectrum	350-2000nm
Temperature range	-150°C to 120°C
Defects	None

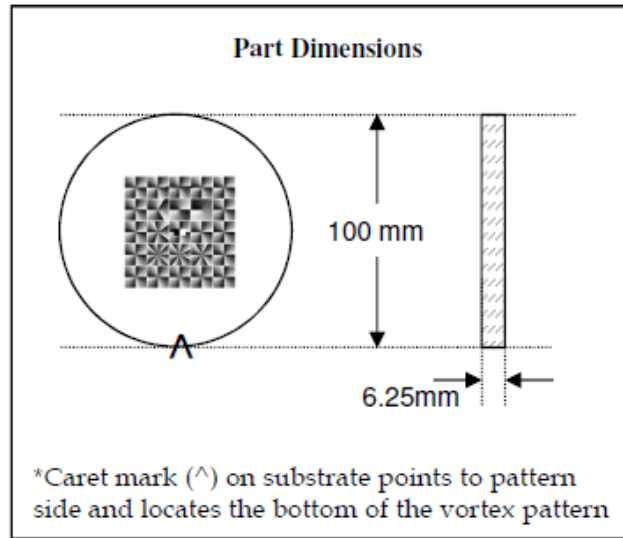

Charge Map

4	4	4	4	4
4	3	2	1	4
4	5		4	4
4	8	7	6	4
4	4	4	4	4

^

*Pattern side up
Blue boundary indicates clear aperture

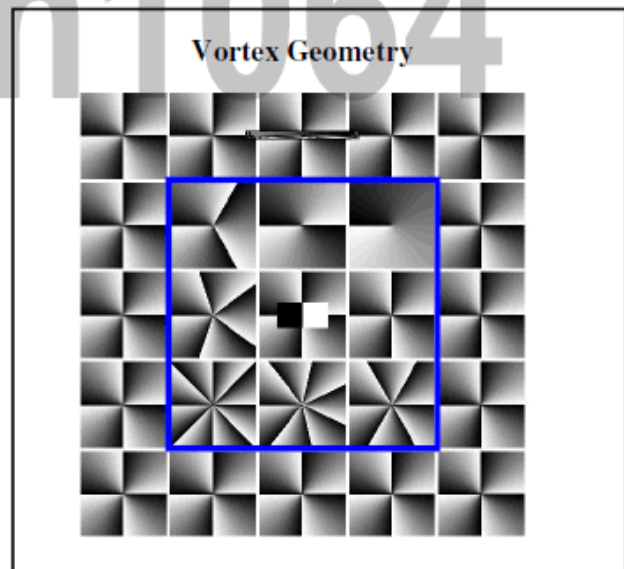

Vortex Phase Plate

VPP-m1340

Properties	
Master	U13087E
Pattern dimension	~50 x 50
Vortex aperture	10 x 10mm
Charge	Various
Wavelength	1340 nm
Material	Polymer replicated on glass substrate
Transmission spectrum	350-2000nm
Temperature range	-150°C to 120°C
Defects	None

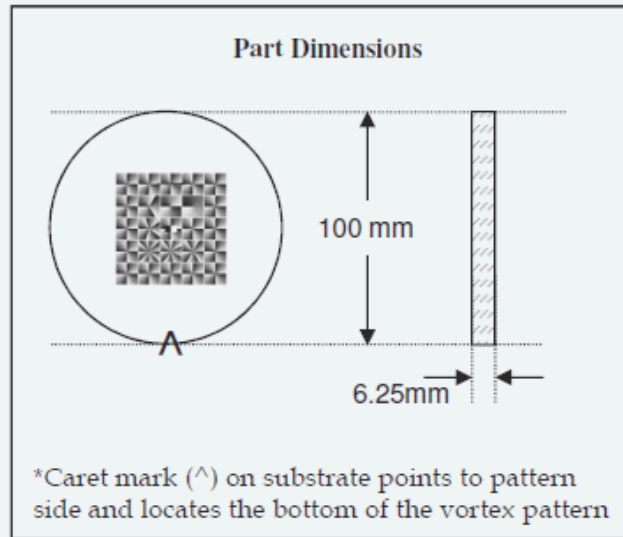

Charge Map

4	4	4	4	4
4	3	2	1	4
4	5		4	4
4	8	7	6	4
4	4	4	4	4

^

*Pattern side up
Blue boundary indicates clear aperture

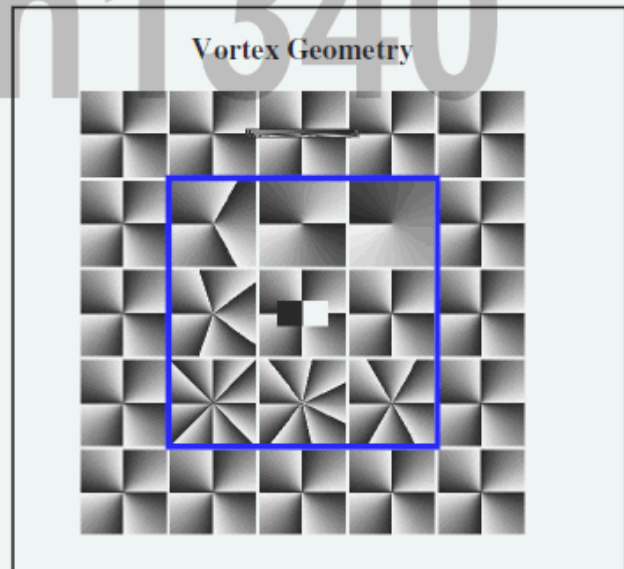

Vortex Phase Plate

VPP-m1550

Properties	
Master	U14077E
Pattern dimension	~50 x 50
Vortex aperture	10 x 10mm
Charge	Various
Wavelength	1550 nm
Material	Polymer replicated on glass substrate
Transmission spectrum	350-2000nm
Temperature range	-150°C to 120°C
Defects	None

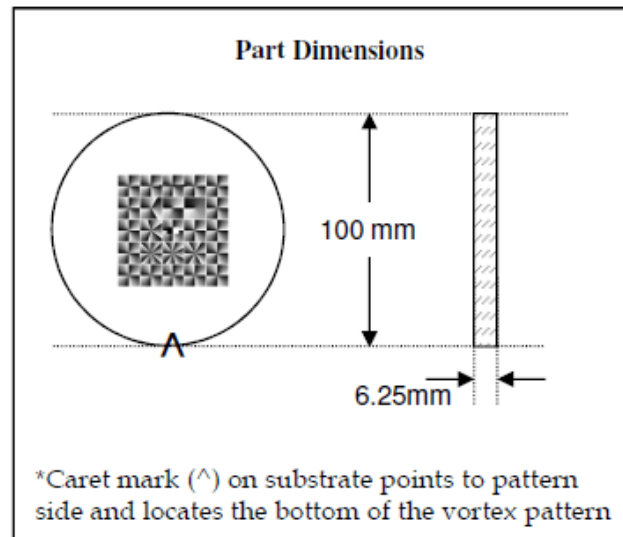

Charge Map

4	4	4	4	4
4	3	2	1	4
4	5		4	4
4	8	7	6	4
4	4	4	4	4

^

*Pattern side up
Blue boundary indicates clear aperture

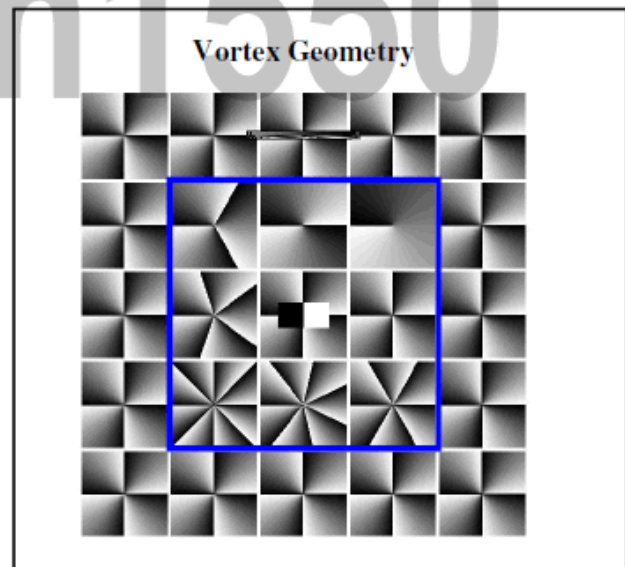

Vortex Phase Plate

VPP-m1792

Properties	
Master	U13103E
Pattern dimension	~50 x 50
Vortex aperture	10 x 10mm
Charge	Various
Wavelength	1792nm
Material	Polymer replicated on glass substrate
Transmission spectrum	350-2000nm
Temperature range	-150°C to 120°C
Defects	None

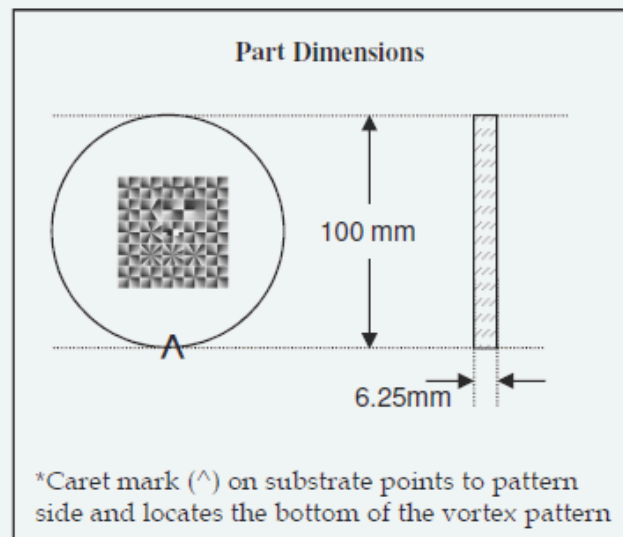

Charge Map

4	4	4	4	4
4	3	2	1	4
4	5		4	4
4	8	7	6	4
4	4	4	4	4



*Pattern side up
 Blue boundary indicates clear aperture

Vortex Geometry

